

**Frischwasserspeicher**  
**Fresh water storage tank**  
**Ballon d'eau fraiche**  
**Accumulatori d'acqua dolce**  
**JHS 600 – 2000**

**DIN**

**EN 12897**  
**EnEV 730.02**  
**ErP 812/2013**  
**ErP 814/2013**

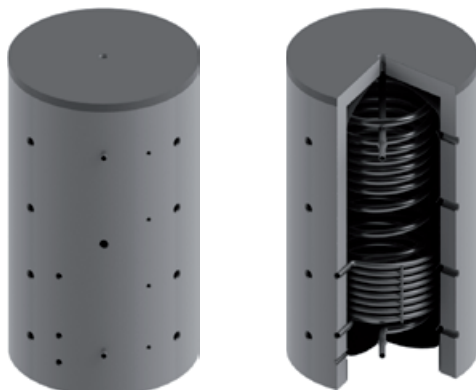

**Bauart**

**Design | Structure | Struttura**

Die Speicher werden aus hochwertigem Stahl nach EN 10025 gefertigt.  
 Die Wärmetauscher bestehen aus Edelstahl V4A. Die Speicher sind innen unbehandelt.

**EN** The storage tanks are made from high quality steel in accordance with EN 10025.

The heat exchanger is made from stainless steel (V4A).  
 The tanks are not treated on the inside.

**FR** Les ballons sont fabriqués en acier de grande qualité, selon la norme EN 10025.

Les échangeurs de chaleur sont en acier inoxydable au molybdène.  
 L'intérieur des ballons n'est pas traité.

**IT** Gli accumulatori sono realizzati in acciaio pregiato secondo la norma EN 10025.

Lo scambiatore di calore è realizzato in acciaio inossidabile V4A.  
 L'interno degli accumulatori non è trattato.

**Lieferumfang**

**Delivery | Livraison | Consegna**

Bedienungsanleitung Operation manual   Mode d'emploi   Istruzioni per l'uso	1 x

## Schutz vor Korrosion

### Anti-corrosion protection | Protection contre la corrosion | Protezione anticorrosiva

Innen sind die Speicher unbehandelt. Aussen sind die Speicher mit einem Antikorrosionslack lackiert.  
Der Wellrohrwärmetauscher ist aus hochwertigem Edelstahl V4A gefertigt.

**EN** The storage tanks are untreated on the interior. The storage tanks are externally coated with a corrosion-protection paint. The corrugated pipe heat exchanger is made of high-quality stainless steel V4A.

**FR** À l'intérieur, les réservoirs ne sont pas traités. À l'extérieur, les réservoirs sont recouverts d'une laque anticorrosion. L'échangeur thermique est fabriqué en acier inoxydable V4A haut de gamme.

**IT** L'interno degli accumulatori non è trattato. Gli accumulatori sono verniciati all'esterno con uno smalto resistente alla corrosione. Lo scambiatore di calore a tubi corrugati è realizzato in pregiato acciaio inossidabile V4A.

## Wärmetauscher

### Heat exchanger | Échangeur de chaleur | Scambiatore di calore

**Heizungswasser:** Ein eingeschweisster grossflächiger Wärmetauscher aus Stahlrohr.  
**Brauchwasser:** Ein eingeschweisstes Wellrohr aus Edelstahl V4A.

**EN Heating water:** A welded large-surface heat exchanger made from a stainless steel pipe  
**Service water:** A welded corrugated tube from stainless steel V4A.

**FR Eau de chauffage:** Un échangeur de chaleur grande surface soudé en tube d'acier.  
**Eau sanitaire:** Un tube ondulé soudé en Acier inoxydable V4A au molybdène.

**IT Acqua di riscaldamento:** Uno scambiatore di calore saldato di grande superficie in tubo d'acciaio.  
**Acqua per uso domestico:** Un tubo ondulato saldato in acciaio inossidabile V4A.

## Isolierung

### Insulation | Isolation | Isolamento

#### TopShell

Isolierung aus Hightech Faservlies. Skaimantel mit Reissverschluss, inklusive Rosetten und Abdeckhaube.  
Brandschutzklasse B2. Silber. Lose geliefert.

#### Variante

Isolierung aus Hightech Faservlies. PS-Mantel und Hakenleiste, inklusive Rosetten und Abdeckhaube.  
Brandschutzklasse B2. Farbe Silber.

#### EN TopShell

Insulation made of high-tech fibre fleece. Skai jacket with zip, including cover plates and hood. Fire-resistance rating B2. Silver. Supplied loose.

#### FR TopShell

Isolation en tissu fibreux high-tech Enveloppe en skai avec fermeture à glissière, y compris rosettes et capot. Classe allemande de protection incendie B2. Argent. Livrée non montée.

#### IT TopShell

Isolamento in tessuto non tessuto high-tech. Mantello in skai pre-assemblato con cerniera, dotato di rosette e calotta di copertura. Classe di resistenza antincendio B2. Argento. Consegna sfusa.

#### Alternative

Insulation made of high-tech fibre fleece. PS jacket and hook rack, including cover plates and hood. Fire-resistance rating B2. Silver.

#### Alternative

Isolation en tissu fibreux high-tech Enveloppe en PS équipée d'un support à crochets préinstallé, y compris rosettes et capot. Classe allemande de protection incendie B2. Couleur argent.

#### Alternativa

Isolamento in tessuto non tessuto high-tech. Mantello in PS e barra con ganci, rosette e calotta di copertura incluse. Classe di resistenza antincendio B2. Colore argento.

TopShell

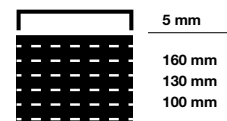

**Frischwasserspeicher**  
**Fresh water storage tank**  
**Ballon d'eau fraîche**  
**Accumulatori d'acqua dolce**  
**JHS 600 – 2000**

Typ JHS		600	800	1000	1250	1500	2000
Bruttoinhalt Gross capacity   Contenance brute   Contenuto lordo	l	560	718	887	1266	1500	2015
Nettoinhalt Net capacity   Contenance nette   Contenuto netto	l	509	655	814	1180	1406	1942
Ø mit Isolierung with insulation   avec isolation   con isolamento	mm	900	990	990	1150	1260	1420
Ø ohne Isolierung without insulation   sans isolation   senza isolamento	mm	700	790	790	950	1000	1100
Höhe mit Isolierung Height with insulation   Hauteur avec isolation   Altezza con isolamento	mm	1700	1740	2090	2060	2250	2480
Kippmass Tilted dimension   Cote de basculement   Altezza in raddrizzamento	mm	1690	1740	2085	2070	2230	2400
Betriebsdruck Heizung Heater operating pressure   Pression de service du chauffage   Pressione d'esercizio riscaldamento	bar	3	3	3	3	3	3
Betriebsdruck Wasser Water operating pressure   Pression de service de l'eau   Pressione d'esercizio acqua	bar	6	6	6	6	6	6
max. Betriebstemperatur max. operating temperature   Temp. de service max.   Temperatura max. d'esercizio	°C	95	95	95	95	95	95
Gewicht Weight   Poids   Peso	kg	154	164	180	279	288	356
Art.Nr. 200206... Part no.   Réf.   Art.n.		0600	0800	1000	1250	1500	2000
<b>Isolierung</b> Insulation   Isolation   Isolamento	<b>EU</b>	<b>TopShell 100</b>				<b>TopShell 130</b>	<b>TopShell 100</b>
Wärmeverlust Heat losses   Pertes thermiques   Perdita di calore	kWh/24h	2.89	3.12	3.38	3.82	4.0	-
ErP-Klasse ErP class   Classe ErP   Classe ErP		C	C	C	C	C	-
Gewicht Weight   Poids   Peso	kg	18	23	30	35	38	45
Art.Nr. 300113... Part no.   Réf.   Art.n.		0601	0801	1001	1251	1502	2001
<b>Isolierung</b> Insulation   Isolation   Isolamento	<b>CH</b>	<b>TopShell 100</b>				<b>TopShell 130</b>	<b>TopShell 160</b>
Art.Nr. 300113... Part no.   Réf.   Art.n.		0601	0801	1001	1251	1502	2003



Typ JHS		600		800		1000		1250		1500		2000	
<b>Glattrohrwärmetauscher unten</b> Bottom heating coil   Échangeurs de chaleur bas   Serpentino inferiore	m <sup>2</sup>	1.8		2.5		2.8		2.8		2.7		3.7	
<b>Inhalt Glattrohrwärmetauscher</b> Heating coil capacity   Contenance échangeurs de chaleur   Contenuto serpentinis de chaleur	l	8.3		11.6		13.0		13.0		12.6		17.3	
<b>Heizfläche Edelstahlwellrohr</b> Heating surface stainless steel corrugated pipe   Surface de chauffe du tube ondulé en acier inoxydable   Superficie riscaldante tubo ondulato	m <sup>2</sup>	5.5		6.0		6.0		9.8		9.8		9.8	
<b>Inhalt Edelstahlwellrohr</b> Stainless steel corrugated pipe capacity   Contenance du tube ondulé en acier inoxydable   Contenuto tubo ondulato	l	28.1		31.0		31.0		51.0		51.0		51.0	
<b>Puffertemperatur</b> Buffer tank temperature   Température du ballon   Temperatura tampone	°C	60	80	60	80	60	80	60	80	60	80	60	80
<b>Warmwasserdauerleistung</b> Hot water continuous output   Régime continu eau chaude   Potenza continua acqua calda 10°C / 45°C / 80°C	l/min	7.2	11.6	7.8	12.0	7.8	12.0	13.5	22.6	13.5	22.6	13.5	22.6
<b>max. Warmwasserdauerleistung</b> Max. hot water continuous output   Régime continu maxi eau chaude   Potenza continua acqua calda max.	kW	18	31	20	34	20	34	32	55	32	55	32	55

**Frischwasserspeicher**  
**Fresh water storage tank**  
**Ballon d'eau fraiche**  
**Accumulatori d'acqua dolce**  
**JHS 600 – 2000**

600 – 2000

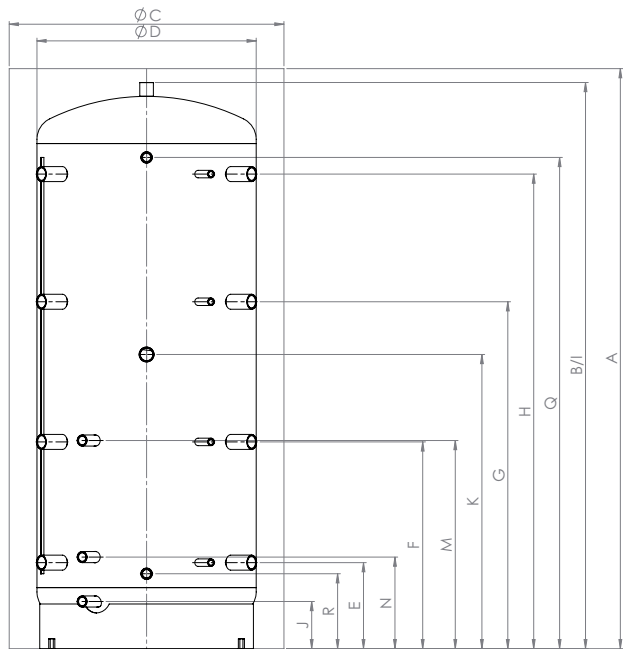

600 – 2000

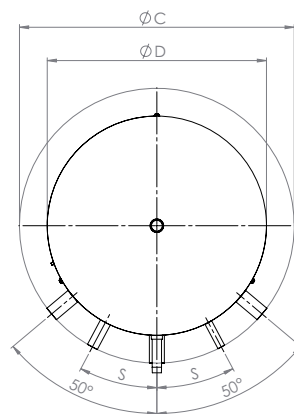

600 – 2000





	Verwendung Usage Utilisation Uso	Dimension Dimension Dimension Dimensione	600	800	1000	1250	1500	2000
A	Höhe Height   Hauteur   Altezza	 – mm	1700	1740	2090	2060	2220	2420
B		 – mm	1650	1690	2040	2010	2170	2370
C	Ø	 – mm	900	990	990	1150	1200	1300
D		 – mm	700	790	790	950	1000	1100
E	Anschluss 1 Connection   Raccord   Collegamento	 – mm	230	260	310	310	380	320
		G" – mm	1 ½"	1 ½"	1 ½"	1 ½"	1 ½"	1 ½"
		 – G"	½"	½"	½"	½"	½"	½"
F	Anschluss 2 Connection   Raccord   Collegamento	 – mm	610	630	745	745	825	900
		G" – mm	1 ½"	1 ½"	1 ½"	1 ½"	1 ½"	1 ½"
		 – G"	½"	½"	½"	½"	½"	½"
G	Anschluss 3 Connection   Raccord   Collegamento	 – mm	990	1030	1250	1250	1350	1490
		G" – mm	1 ½"	1 ½"	1 ½"	1 ½"	1 ½"	1 ½"
		 – G"	½"	½"	½"	½"	½"	½"
H	Anschluss 4 Connection   Raccord   Collegamento	 – mm	1380	1430	1710	1710	1760	2020
		G" – mm	1 ½"	1 ½"	1 ½"	1 ½"	1 ½"	1 ½"
		 – G"	½"	½"	½"	½"	½"	½"
I	Anschluss oben Connection above   Raccord du haut   Collegamento superiore	 – mm	1650	1690	2040	2010	2170	2370
		G" – mm	1 ¼"	1 ¼"	1 ¼"	1 ¼"	1 ¼"	1 ¼"
J	Anschluss unten Connection below   Raccord du bas   Collegamento inferiore	 – mm	145	170	170	190	235	220
		G" – mm	1"	1"	1"	1"	1"	1"
K	Elektroheizung zum Einschrauben* Screw-in Immersion heater*   Résistances à visser*   Resistenza elettrica da avvitare*	 – mm	850	915	1060	1060	1350	1315
		G" – mm	1 ½"	1 ½"	1 ½"	1 ½"	1 ½"	1 ½"
M	VL Glattrohrwärmetauscher unten Bottom heating coil   Échangeurs de chaleur bas   Serpentino inferiore	 – mm	790	690	750	760	780	1120
		G" – mm	1"	1"	1"	1"	1"	1"
N	RL Glattrohrwärmetauscher unten Bottom heating coil   Échangeurs de chaleur bas   Serpentino inferiore	 – mm	250	330	330	330	390	320
		G" – mm	1"	1"	1"	1"	1"	1"
Q	Edelstahlwellrohr Warmwasser Hot water stainless steel corrugated pipe   Tube ondulé en acier inoxydable eau chaude   Scambiatore di calore con tubo ondulato in acciaio inossidabile	 – mm	1380	1450	1770	1680	1835	1805
		G" – mm	1"	1"	1"	1"	1"	1"
R	Edelstahlwellrohr Kaltwasser Cold water stainless steel corrugated pipe   Tube ondulé en acier inoxydable eau froide   Tubo ondulato acqua fredda	 – mm	230	260	270	310	335	305
		G" – mm	1"	1"	1"	1"	1"	1"

\*Einbaumöglichkeit: 1 x Elektroheizung zum Einschrauben  
Installation option: 1 x Screw-in Immersion heater | Option d'installation: 1 x Résistances à visser | Opzione di installazione: 1 x Resistenza elettrica da avvitare

 mit Isolierung  
with insulation | avec isolation | con isolamento

 ohne Isolierung  
without insulation | sans isolation | senza isolamento

 Höhe  
Height | Hauteur | Altezza

 Fühler  
Sensor | Sonde | Sensore